

FRAMELESS SHOWER DOOR

H A R D W A R E A N D S U P P L I E S



An ISO9001:2008 Certified Company
C.R. LAURENCE COMPANY

Worldwide Manufacturer and Supplier

Glazing, Architectural, Railing, Screen, Construction, Industrial, and Automotive Supplies



BASKING IN ELEGANCE



WOW!

Custom Angled Enclosure

Webster's Dictionary describes the word "bask" as "To expose oneself to pleasant warmth," and "To thrive or take pleasure." Well, that certainly describes a creatively designed frameless shower. Take pleasure in the elegance it brings to your designer bathroom. Enjoy the pleasant warmth of the showering waters in an enclosure that is the focal point of a room that most of us spend a lot of time in. Notice the reaction you get when others see the investment you have made in your home. Nice, isn't it? And you can make it possible when you work with your local glass shop. Their expertise, along with CRL's selection of beautiful hardware, is how it's done.

**TO SEE MORE BEAUTIFUL SHOWERS,
LOG ON TO CRLAURENCE.COM/GALLERY
AND VISIT OUR SHOWER GALLERY.
IT'S FREE FOR ALL TO SEE-TAKE A LOOK!**



Custom Neo-Angle Enclosure



CAT. NO. EST037
Wall Mount



CAT. NO. EST180
180° Glass-to-Glass



CAT. NO. EST135
135° Glass-to-Glass



CAT. NO. EST090
90° Glass-to-Glass



ESTATE SERIES

3/8" to 1/2"



Estate Hinges for 3/8" (10 mm) to 1/2" (12 mm) tempered safety glass are a uniquely classic design combining mitered edges with curved corners. They are made of solid brass with stainless steel springs. Choose from the elegant Wall Mount Hinge or 90°, 135°, and 180° Glass-to-Glass styles. The self-centering action of the Estate Series Hinge allows the door to be maintained in any position, except when within 15° of the closed position, where they are tapered to assist in centering the door.

SPECIFICATIONS:

Glass Thickness:

3/8" (10 mm) to 1/2" (12 mm)
Tempered Safety Glass

Special Features:

Classic design combines mitered edges with curved corners

Construction:

Solid Brass

Hinge Swings:

90° in and 90° out

Closing Type:

Self-Centering when within 15° of closed position

Cut-Out Required

Includes:
Gaskets, Screws, and Glass Fabrication Dimensions

FINISHES:



Chrome



*MAXIMUM CAPACITIES	3/8" (10 MM) GLASS		1/2" (12 MM) GLASS	
	WEIGHT	DOOR WIDTH	WEIGHT	DOOR WIDTH
Using Two Hinges	80 lbs/36 kg	28"/711 mm	80 lbs/36 kg	26"/660 mm
Using Three Hinges	120 lbs/54 kg	34"/864 mm	120 lbs/54 kg	30"/762 mm

*NOTE: Do not exceed maximum door weight or width when choosing proper quantity of hinges.



Custom Inline Enclosure

IMAGINATION BECOMES REALITY

Imagine the perfect bathroom. What would it be like? Would it include an elegant (dare we say extravagant) 'all-glass' shower? It's easy to imagine and, with C.R. Laurence Frameless Shower Hardware, easy to make a reality. The variety of our product line includes over 25 distinct series of hinges that can complement and accentuate any décor. Complementary hardware, such as pull handles, knobs, towel bars, glass clamps, channels, mirrors, and mirrored accessories make just about anything you imagine possible. We make it all available to your local glass shop from our distribution facilities in North America, Europe, and Australia.

**TO SEE MORE
BEAUTIFUL SHOWERS,
LOG ON TO
CRLAURENCE.COM/GALLERY
AND VISIT OUR
SHOWER GALLERY.**



Custom Double Door Inline Enclosure

BM SERIES PULL HANDLE/TOWEL BAR COMBINATIONS WITH METAL WASHERS



SPECIFICATIONS:

Material:

3/4" (19 mm) Diameter Brass Tubing
(1.5 mil thick), 1-1/4" (31.8 mm)
Diameter Metal Washers

Glass Thickness Range:

1/4" (6 mm) to 1/2" (12 mm)

Hole Diameter Required:

1/2" (12 mm)

Center-to-Center Hole Spacing:

6" Pull = 6" (152 mm)

8" Pull = 8" (203 mm)

12" Pull = 12" (305 mm)

12" Towel Bar = 12" (305 mm)

18" Towel Bar = 18" (457 mm)

20" Towel Bar = 20" (508 mm)

22" Towel Bar = 22" (559 mm)

24" Towel Bar = 24" (610 mm)

AVAILABLE SIZES:

CAT. NO. BM6X18 6" Pull / 18" Towel Bar

FINISHES:



The BM Series of Pull Handle/Towel Bar Combinations With Metal Washers are provided with all the hardware required for installation. They are constructed of 1.5 mil thick heavy brass tubing. Each set consists of a pull handle/towel bar set, along with decorative metal back-up washers and plastic washers to protect against glass-to-metal contact.

CREATIONS YOU CAN ENJOY

There are lots of things that can bring you enjoyment, but there's a special joy in having something that is unique. A bathroom that you design expressly for your home is an opportunity to express your creativity by bringing something one-of-a-kind into what may be an otherwise plain environment. Add a little pizzazz! It's your space, so why not get exactly what you want? The glass experts at your local glass shop work with CRL's Technical Sales Specialists and a wide variety of frameless shower hardware choices to create an attractive and functional shower that you can enjoy for many years. Go ahead, be creative!

**TO SEE MORE BEAUTIFUL SHOWERS,
LOG ON TO
CRLAURENCE.COM/GALLERY
AND VISIT OUR SHOWER GALLERY.**



Custom Angled Enclosure



Custom 90 Degree Enclosure



Custom Double Door Inline Enclosure

TRADITIONAL GLASS CLAMPS

- *Varieties to Accommodate 5/16" (8 mm) to 1/2" (12 mm) Thick Glass*

Our solid brass Traditional Glass Clamps are designed to secure glass panels in contemporary shower enclosures. They assist in maintaining the frameless appearance, and provide a clean looking alternative to U-Channel. All Traditional Clamps feature solid brass construction and a variety of finishes to match our complete line of Shower Door Hinges. Appropriate mounting screws and one set of clear gaskets are included with each Clamp. Extra Cat. No. UCG77 Clear Gaskets may be ordered separately.

FINISHES:



Chrome



CAT. NO. UC77

Size: 1-3/4" (44 mm) Wide x
1-3/4" (44 mm) High

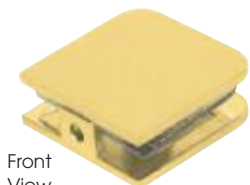

Front View



Rear View

STANDARD FIXED PANEL U-CLAMP

- *For 5/16" (8 mm) to 3/8" (10 mm) Thick Glass*

SPECIFICATIONS:

Material: Solid Brass

Available Finishes: Shown at top of page

Glass Thickness Range: 5/16" (8 mm) to 3/8" (10 mm)

Hole Diameter Required: 5/8" (16 mm) or 3/4" (19 mm)

Includes: Mounting Screws (for Wall Clamps) and Clear Gaskets

Note: An additional set of clear gaskets (Cat. No. UCG77) is required for 5/16" (8 mm) glass

Standard Fixed Panel U-Clamps mount directly to the wall, ceiling or floor to secure vertical fixed glass panels. Clearance between the glass and wall is from 5/32" (4 mm) to 3/16" (5 mm). Clear silicone can be used to seal the gap and provide a clean, water resistant appearance.

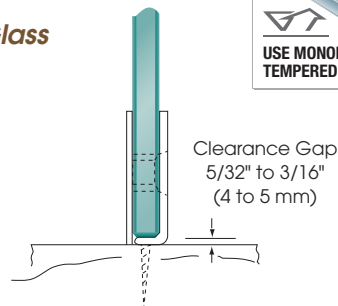



Custom Angled Enclosure

ADDING THE WOW! FACTOR

Imagine walking into one of these bathrooms for the first time. Your reaction might be "WOW"! That's what you can add to your bathroom, the WOW! Factor, when your remodeling plan includes a modern frameless shower enclosure. Each of these showers is a stunning statement of what a properly designed, quality built frameless enclosure can add to the beauty and value of a home. Each enclosure is adorned with C.R. Laurence Frameless Shower Hardware. As you browse through this catalog you'll see many examples of how we can add the WOW! to most every bathroom.



Custom Curved Glass Enclosure



Custom 90 Degree Enclosure

**TO SEE MORE BEAUTIFUL SHOWERS, LOG ON TO
CRLAURENCE.COM/GALLERY AND VISIT OUR SHOWER GALLERY.**

STANDARD 90° GLASS CLAMP

• For 5/16" (8 mm) to 3/8" (10 mm) Thick Glass

SPECIFICATIONS:

Materials: Solid Brass or Stainless Steel

Available Finishes: Brass, Chrome, Satin Brass, Brushed Satin Chrome, Satin Chrome (Matte), Gold Plated, Gun Metal, Antique Brushed Nickel, Polished Nickel, Brushed Nickel, Satin Nickel, Ultra Brass, Antique Brass, Antique Bronze, Brushed Bronze, Oil Rubbed Bronze, Antique Brushed Copper, White, Black, Red, Polished Stainless, and Brushed Stainless.

Glass Thickness Range: 5/16" (8 mm) to 3/8" (10 mm)

Hole Diameter Required: 5/8" (16 mm) or 3/4" (19 mm) each panel

Includes: Gaskets and Wood Screw for wall mount application

Note: An additional set of gaskets is required for 5/16" (8 mm) glass (Cat. No. UCG77)

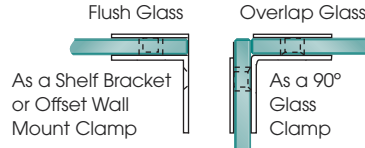

A truly versatile clamp that has two uses: as a 90° Clamp for vertical fixed panels in glass shower enclosures; as a bracket for horizontal glass shelves within the enclosure. Clamp design allows for flush mounting of shelf to wall, or for adjoining panels to meet with a minimal gap.

CAT. NO. GCB90
Size: 1-3/4" (44 mm) Wide x
1-3/4" (44 mm) High
(each plate)



CLEAR POLYCARBONATES, VINYL SEALS, AND EDGE WIPES

POLYCARBONATE 'U' WITH BULB ATTACHMENT

NEW!

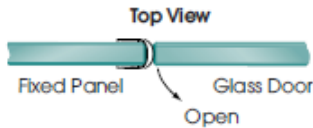

The Clear Polycarbonate 'U' With Bulb Attachment is a versatile seal that can be mounted to the edge of a door or panel for a variety of installation configurations. The soft Bulb portion of the Seal allows doors to swing both in and out of the enclosure if desired.

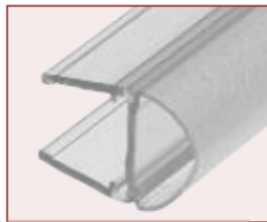

98" (2.49 M) STOCK LENGTHS

CAT. NO.	GLASS SIZE
PCR10	3/8" (10 mm)

ONE-PIECE BOTTOM RAIL WITH CLEAR WIPE

• *Single-Piece Bottom Sweep*

This ultra clear One-Piece Bottom Rail is snapped on the bottom of the door to achieve a seal. Because it is a single-piece sweep, it means the vinyl seal that hangs down from the sweep will firmly direct the water back into the shower enclosure.

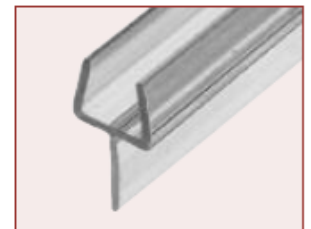
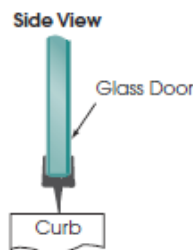

98" (2.49 M) STOCK LENGTHS

CAT. NO.	"X"	"Y"	GLASS SIZE
P501BR	7/16" (11 mm)	7/16" (11 mm)	3/8" (10 mm)
P661BR	1/2" (12 mm)	7/16" (11 mm)	1/2" (12 mm)



Custom 90 Degree Enclosure



Custom 90 Degree Enclosure



Custom Sliding Door Enclosure



Custom Curved Enclosure



Custom Inline Enclosure



Custom 90 Degree Enclosure



Custom Curved Enclosure



Custom Neo-Angle Enclosure



Custom 90 Degree Enclosure



Custom 90 Degree Enclosure



Custom 90 Degree Enclosure



Custom Inline Enclosure



Custom 90 Degree Enclosure



Custom Neo-Angle Enclosure



Custom Inline Enclosure



Custom Curved Enclosure



Custom 90 Degree Double Door Enclosure



Custom 90 Degree Enclosure



Custom 90 Degree Enclosure



Custom Sliding Door Enclosure

HYDROSLIDE SLIDING SHOWER DOOR KITS

- **Excellent Design for Compact Areas**
- **Clean, Sleek Lines**
- **Available in Four Stock Finishes, Custom Finishes Available**
- **Custom Units Available**
- **Standard 180 Degree Installation is One Fixed Panel and One Door**

FINISHES:



5/16" to 3/8"

90 DEGREE WALL-TO-GLASS INSTALLATION

Uses our 180 Degree Standard Kit plus a 90 Degree Wall-to-Glass Accessory Kit

180 DEGREE WALL-TO-WALL INSTALLATION

Uses our 180 Degree Standard Kit



See Page 209S for our PC0890 or PC1090 Door Seal ideal for use with our Hydroslide System

180 DEGREE STANDARD KIT CONSISTS OF:

- 1 - Sliding Glass Door Upper Track
- 2 - Hangers for Sliding Glass Door
- 2 - Sliding Glass Door Rollers
- 2 - Sliding Glass Door Roller Stops
- 1 - Sliding Glass Door Floor Guide
- 2 - 90 Degree Wall-to-Upper Track Connectors
- 2 - 180 Degree Glass-to-Sliding Track Connectors
- 1 - 36" (914 mm) Half-Round SDT980 Threshold
- 1 - 98" (2489 mm) DK98L L-Seal for Wall

NOTE: Bottom Fixed Glass Attachments, Handles or Knobs must be ordered separately.

*90 DEGREE WALL-TO-GLASS ACCESSORY KIT CONSISTS OF:

- 1 - 90 Degree Glass-to-Sliding Track Connector
- 1 - 90 Degree Wall-to-Glass Bracket

*90 Degree Units require that you order one 180 Degree Standard Kit plus one 90 Degree Wall-to-Wall Accessory Kit

SPECIFICATIONS:

Materials: Plated or Lacquered Solid Brass Fittings; Anodized Aluminum Sliding Door Track

Glass Thickness Range: 5/16" (8 mm) to 3/8" (10 mm) Tempered Safety Glass (Not Included)

Maximum Door Weight: 88 lbs. (40 kg)

Fabrication: Holes Required in Fixed Panel and Door

Include: Gaskets, Screws, and Glass Fabrication Information. Complete installation instructions, along with glass and metal cutting formula, available at crlaurence.com/shower-sliders

180 DEGREE STANDARD KIT 60" (1524 MM) CAT. NO.	180 DEGREE STANDARD KIT 84" (2134 MM) CAT. NO.	90 DEGREE WALL-TO-GLASS ACCESSORY KIT CAT. NO.	FINISH
HYDK60CH	HYDK84CH	HYDA9CH	Brite Anodized/Chrome
HYDK60BR	HYDK84BR	HYDA9BR	Brite Gold Anodized/Brass
HYDK60BN	HYDK84BN	HYDA9BN	Brushed Nickel
HYDK60RB	HYDK84ORB	HYDA9ORB	Oil Rubbed Bronze



C.R. LAURENCE COMPANY

crlaurence.com

218S | crlaurence.ca crlaurence.qc.ca crlaurence.com.mx crlaurence.com.au usalum.com

HYDROSLIDE SHOWER DOOR COMPONENTS

Hydroslide component parts can be ordered as replacement parts, or you can order the individual parts to fabricate your own custom installation.



SLIDING SHOWER DOOR UPPER TRACK

The extruded aluminum Sliding Shower Door Upper Track is available in two lengths and four finishes. Easily cut to length for your installation. Longer lengths available by special order.

BRITE ANODIZED CAT. NO.	BRITE GOLD ANODIZED CAT. NO.	BRUSHED NICKEL ANODIZED CAT. NO.	OIL RUBBED BRONZE CAT. NO.	LENGTH
HYD60BA HYD84BA	HYD60BGA HYD84BGA	HYD60BN HYD84BN	HYD60ORB HYD84ORB	60" (1524 mm) 84" (2134 mm)

SLIDING DOOR HANGER KIT

CAT. NO.	FINISH
HYD01CH	Polished Chrome
HYD01BR	Polished Brass
HYD01BN	Brushed Nickel
HYD01ORB	Oil Rubbed Bronze



180° GLASS-TO-SLIDING TRACK CONNECTOR

CAT. NO.	FINISH
HYDG180CH	Polished Chrome
HYDG180BR	Polished Brass
HYDG180BN	Brushed Nickel
HYDG180ORB	Oil Rubbed Bronze



For attaching the fixed glass to the Sliding Shower Door Upper Track in 180° installations.

ROLLER STOP KIT

CAT. NO.	COLOR
HYD02	Black



Kit consists of two Roller Stops with Screws.

90° GLASS-TO-SLIDING TRACK CONNECTOR

CAT. NO.	FINISH
HYDG90CH	Polished Chrome
HYDG90BR	Polished Brass
HYDG90BN	Brushed Nickel
HYDG90ORB	Oil Rubbed Bronze



For attaching the fixed glass to the Sliding Shower Door Upper Track in 90° installations.

SNAP-IN SCREW COVER KIT

CAT. NO.	FINISH
HYD04CH	Polished Chrome
HYD04BR	Polished Brass
HYD04BN	Brushed Nickel
HYD04ORB	Oil Rubbed Bronze

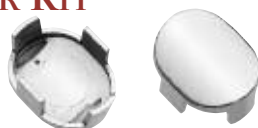

Kit consists of two Snap-In Screw Covers.

90° WALL-TO-UPPER TRACK CONNECTOR

CAT. NO.	FINISH
HYDW90	Mill



For attaching the Sliding Shower Door Upper Track to a wall at 90°.

SLIDING DOOR FLOOR GUIDE KIT

CAT. NO.	FINISH
HYD03CH	Polished Chrome
HYD03BR	Polished Brass
HYD03BN	Brushed Nickel
HYD03ORB	Oil Rubbed Bronze



Kit consists of one Floor Guide and two Screws.

90° WALL-TO-GLASS BRACKET

CAT. NO.	FINISH
HYD05CH	Polished Chrome
HYD05BR	Polished Brass
HYD05BN	Brushed Nickel
HYD05ORB	Oil Rubbed Bronze



For securing a glass panel at 90° to the wall. Includes two Screws and Snap-In Screw Covers.

REPLACEMENT WHITE BUSHING SPACER PACK

- Included With Each Hydroslide Sliding Door Kit
- Offered Separately Here as Replacement Packs
- Pack Contains Two Bushings of Three Different Sizes

The White Bushing Spacer Pack is included in each Hydroslide Sliding Shower Door Kit, but this replacement pack is available if needed. Two each of three different bushings are included. The appropriate size is selected to help fill the holes drilled in glass for the Hangers to help prevent slippage.



CAT. NO. HYDS

90° HYDROSLIDE HEADER BRACKET

To be used when two Hydroslide doors come together in a 90° corner.
NOTE: Sliding panels not to exceed 17" (432 mm) in width.



CAT. NO. HYDH90

HYDROSLIDE BI-FOLD HINGES

NEW!

- **Glass-to-Wall Mount and Glass-to-Glass Models**
Allow Door to Bi-Fold Into Enclosure
- **Four Finishes to Match Hydroslide System**

These Hydroslide Bi-Fold Hinges add a different element to the already popular Hydroslide System. Instead of a standard sliding door, you can now "Bi-Fold" two folding panels of glass into the shower enclosure, creating a larger opening than the single sliding door will allow. Made of solid brass, they are available in four popular finishes.



5/16" to 3/8"

FINISHES:



Polished Chrome Polished Brass Brushed Nickel Oil Rubbed Bronze



CAT. NO. HYDH037
Glass-to-Wall Mount

SPECIFICATIONS:

Glass Thickness: 5/16" (8 mm) to 3/8" (10 mm)
Tempered Safety Glass

Construction: Solid Brass

Hinge Swings: Bi-Fold into Shower Enclosure

Closing Type: Free Swinging

Holes Required in Glass

Includes: Gaskets, Screws, and Glass Fabrication Dimensions

Maximum Capacities: Do Not Exceed Either 48" (1219 mm) or 100 lbs. (45 kg) for Both Folding Doors Combined. Use Two Hinges Only on Each Folding Panel.



CAT. NO. HYDH180
180° Glass-to-Glass



Panels "Fold" Into the Shower



Hydroslide Bi-Fold Hinges require holes in the glass

CRL SHOWERS ONLINE



- **Revolutionary Program Generates "Go" Glass Sizes From Your Field Measurements**
- **Web-Based So You Have 24 Hour Access**
- **Sizes for Shower Enclosures Can Be Completed in Just A Few Minutes**
- **Upon Completion of Data Entry, Simply Click on the "Print" Icon to Generate Complete Glass Sizes and Templates**
- **You Have the Ability to Change the Default Deductions for Glass Sizing**
- **Continued Upgrades to Program Provided at No Extra Expense**

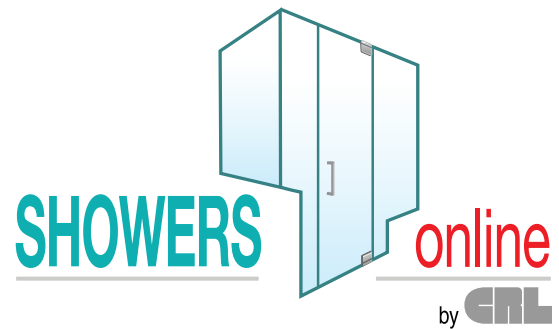

**WEB-BASED DESIGN, GLASS SIZING,
QUOTE AND ORDERING PROGRAM**

**FREE 30 DAY TRIAL OFFER
UPON COMPLETION OF INTRODUCTORY WEBINAR
(VISIT CRLAURENCE.COM/ONLINE-APPS)**

See Pages 102S and 103S for Complete Information



C.R. LAURENCE COMPANY

crlaurence.com

220S | crlaurence.ca crlaurence.qc.ca crlaurence.com.mx crlaurence.com.au usalum.com



Custom Sliding Door Enclosure



Custom Inline Enclosure



Custom Neo-Angle Enclosure



Custom Multi-Panel Enclosure



Custom Inline Enclosure



Custom Multi-Panel Enclosure



Custom Neo-Angle Enclosure



Custom Neo-Angle Enclosure



Custom Sliding Enclosure



Custom Sliding Enclosure



Custom 90 Degree Enclosure

FRAMELESS SHOWER DOOR

HARDWARE AND SUPPLIES

IMAGINATION TO REALITY

Designing a beautiful and elegant frameless shower enclosure begins with a vision... but how do you make it come to life?

Making it possible requires the proper technology. Consult with the Technical Specialists at C.R. Laurence to ensure that beauty meets practicality and that your vision becomes reality!

SD16 CATALOG
10 28 85 Shower Doors and Enclosures

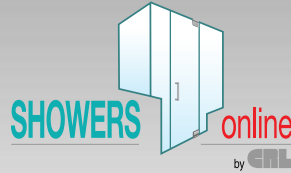

HYDROSLIDE SLIDING SHOWER DOOR SYSTEM

- *Excellent Design for Compact Areas*
- *Clean, Sleek Lines*
- *Standard 180 Degree Installation is One Fixed Panel and One Door*
- *90 Degree Wall-to-Glass Accessory Kit Available*
- *Four Stock Finishes*
- *Custom Units Available*

VISIT OUR SHOWROOMS:

#60 Granada St. Villa Ortigas II, Quezon City
Telephone: +632 8725 8160
Mobile: +63 917 511 5049

CW Home Depot Ortigas - Ortigas Center, Pasig City
Telephone: +632 8633 5539
Mobile: +63 917 511 5073

MC Home Depot - Fort BGC, Taguig City
Telephone: +632 8816 0158
Mobile: +63 917 511 5063

CW Home Depot Alabang - Alabang, Muntinlupa City
Telephone: +632 8771 1591
Mobile: +63 917 511 5083



An ISO9001:2008 Certified Company



C.R. LAURENCE COMPANY

Worldwide Manufacturer and Supplier

Glazing, Architectural, Railing, Screen, Construction, Industrial, and Automotive Supplies



crlaurence.com

usalum.com

crl-arch.com

© COPYRIGHT 2015, C.R. LAURENCE CO., INC.