

# FRAMELESS SHOWER DOOR

H A R D W A R E   A N D   S U P P L I E S



An ISO9001:2008 Certified Company  
**C.R. LAURENCE COMPANY**

Worldwide Manufacturer and Supplier

Glazing, Architectural, Railing, Screen, Construction, Industrial, and Automotive Supplies



# BASKING IN ELEGANCE



**WOW!**

Custom Angled Enclosure

Webster's Dictionary describes the word "bask" as "To expose oneself to pleasant warmth," and "To thrive or take pleasure." Well, that certainly describes a creatively designed frameless shower. Take pleasure in the elegance it brings to your designer bathroom. Enjoy the pleasant warmth of the showering waters in an enclosure that is the focal point of a room that most of us spend a lot of time in. Notice the reaction you get when others see the investment you have made in your home. Nice, isn't it? And you can make it possible when you work with your local glass shop. Their expertise, along with CRL's selection of beautiful hardware, is how it's done.

**TO SEE MORE BEAUTIFUL SHOWERS,  
LOG ON TO [CRLAURENCE.COM/GALLERY](http://CRLAURENCE.COM/GALLERY)  
AND VISIT OUR SHOWER GALLERY.  
IT'S FREE FOR ALL TO SEE-TAKE A LOOK!**



Custom Neo-Angle Enclosure



Custom Inline Enclosure

# IMAGINATION BECOMES REALITY

Imagine the perfect bathroom. What would it be like? Would it include an elegant (dare we say extravagant) 'all-glass' shower? It's easy to imagine and, with C.R. Laurence Frameless Shower Hardware, easy to make a reality. The variety of our product line includes over 25 distinct series of hinges that can complement and accentuate any décor. Complementary hardware, such as pull handles, knobs, towel bars, glass clamps, channels, mirrors, and mirrored accessories make just about anything you imagine possible. We make it all available to your local glass shop from our distribution facilities in North America, Europe, and Australia.

**TO SEE MORE  
BEAUTIFUL SHOWERS,  
LOG ON TO  
[CRLAURENCE.COM/GALLERY](http://CRLAURENCE.COM/GALLERY)  
AND VISIT OUR  
SHOWER GALLERY.**



Custom Double Door Inline Enclosure



**CAT. NO. EST037**  
Wall Mount



**CAT. NO. EST180**  
180° Glass-to-Glass



**CAT. NO. EST135**  
135° Glass-to-Glass



**CAT. NO. EST090**  
90° Glass-to-Glass



# ESTATE SERIES

3/8" to 1/2"



Estate Hinges for 3/8" (10 mm) to 1/2" (12 mm) tempered safety glass are a uniquely classic design combining mitered edges with curved corners. They are made of solid brass with stainless steel springs. Choose from the elegant Wall Mount Hinge or 90°, 135°, and 180° Glass-to-Glass styles. The self-centering action of the Estate Series Hinge allows the door to be maintained in any position, except when within 15° of the closed position, where they are tapered to assist in centering the door.

## SPECIFICATIONS:

### Glass Thickness:

3/8" (10 mm) to 1/2" (12 mm)  
Tempered Safety Glass

### Special Features:

Classic design combines mitered edges with curved corners

### Construction:

Solid Brass

### Hinge Swings:

90° in and 90° out

### Closing Type:

Self-Centering when within 15° of closed position

### Cut-Out Required

**Includes:**  
Gaskets, Screws, and Glass Fabrication Dimensions

## FINISHES:



Chrome



*MAXIMUM CAPACITIES	3/8" (10 MM) GLASS		1/2" (12 MM) GLASS	
	WEIGHT	DOOR WIDTH	WEIGHT	DOOR WIDTH
Using Two Hinges	80 lbs/36 kg	28"/711 mm	80 lbs/36 kg	26"/660 mm
Using Three Hinges	120 lbs/54 kg	34"/864 mm	120 lbs/54 kg	30"/762 mm

\*NOTE: Do not exceed maximum door weight or width when choosing proper quantity of hinges.



Custom 90 Degree Enclosure



Custom 90 Degree Enclosure



Custom Sliding Door Enclosure



Custom Curved Enclosure

# BM SERIES PULL HANDLE/TOWEL BAR COMBINATIONS WITH METAL WASHERS



## SPECIFICATIONS:

### Material:

3/4" (19 mm) Diameter Brass Tubing  
(1.5 mil thick), 1-1/4" (31.8 mm)  
Diameter Metal Washers

### Glass Thickness Range:

1/4" (6 mm) to 1/2" (12 mm)

### Hole Diameter Required:

1/2" (12 mm)

### Center-to-Center Hole Spacing:

6" Pull = 6" (152 mm)

8" Pull = 8" (203 mm)

12" Pull = 12" (305 mm)

12" Towel Bar = 12" (305 mm)

18" Towel Bar = 18" (457 mm)

20" Towel Bar = 20" (508 mm)

22" Towel Bar = 22" (559 mm)

24" Towel Bar = 24" (610 mm)

## AVAILABLE SIZES:

CAT. NO. BM6X18 6" Pull / 18" Towel Bar

## FINISHES:



The BM Series of Pull Handle/Towel Bar Combinations With Metal Washers are provided with all the hardware required for installation. They are constructed of 1.5 mil thick heavy brass tubing. Each set consists of a pull handle/towel bar set, along with decorative metal back-up washers and plastic washers to protect against glass-to-metal contact.

# CREATIONS YOU CAN ENJOY

There are lots of things that can bring you enjoyment, but there's a special joy in having something that is unique. A bathroom that you design expressly for your home is an opportunity to express your creativity by bringing something one-of-a-kind into what may be an otherwise plain environment. Add a little pizzazz! It's your space, so why not get exactly what you want? The glass experts at your local glass shop work with CRL's Technical Sales Specialists and a wide variety of frameless shower hardware choices to create an attractive and functional shower that you can enjoy for many years. Go ahead, be creative!

**TO SEE MORE BEAUTIFUL SHOWERS,  
LOG ON TO  
[CRLAURENCE.COM/GALLERY](http://CRLAURENCE.COM/GALLERY)  
AND VISIT OUR SHOWER GALLERY.**



Custom Angled Enclosure



Custom 90 Degree Enclosure



Custom Double Door Inline Enclosure

# TRADITIONAL GLASS CLAMPS

- *Varieties to Accommodate 5/16" (8 mm) to 1/2" (12 mm) Thick Glass*

Our solid brass Traditional Glass Clamps are designed to secure glass panels in contemporary shower enclosures. They assist in maintaining the frameless appearance, and provide a clean looking alternative to U-Channel. All Traditional Clamps feature solid brass construction and a variety of finishes to match our complete line of Shower Door Hinges. Appropriate mounting screws and one set of clear gaskets are included with each Clamp. Extra Cat. No. UCG77 Clear Gaskets may be ordered separately.

## FINISHES:



Chrome



### CAT. NO. UC77

Size: 1-3/4" (44 mm) Wide x  
1-3/4" (44 mm) High

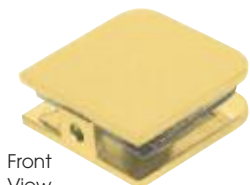

Front View



Rear View

## STANDARD FIXED PANEL U-CLAMP

- *For 5/16" (8 mm) to 3/8" (10 mm) Thick Glass*

### SPECIFICATIONS:

**Material:** Solid Brass

**Available Finishes:** Shown at top of page

**Glass Thickness Range:** 5/16" (8 mm) to 3/8" (10 mm)

**Hole Diameter Required:** 5/8" (16 mm) or 3/4" (19 mm)

**Includes:** Mounting Screws (for Wall Clamps) and Clear Gaskets

**Note:** An additional set of clear gaskets (Cat. No. UCG77) is required for 5/16" (8 mm) glass

Standard Fixed Panel U-Clamps mount directly to the wall, ceiling or floor to secure vertical fixed glass panels. Clearance between the glass and wall is from 5/32" (4 mm) to 3/16" (5 mm). Clear silicone can be used to seal the gap and provide a clean, water resistant appearance.

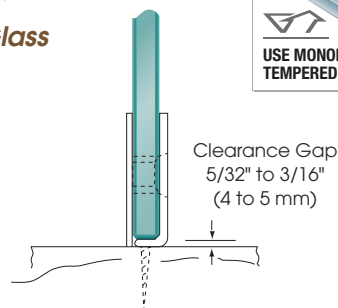





Custom Angled Enclosure

# ADDING THE WOW! FACTOR

Imagine walking into one of these bathrooms for the first time. Your reaction might be "WOW"! That's what you can add to your bathroom, the WOW! Factor, when your remodeling plan includes a modern frameless shower enclosure. Each of these showers is a stunning statement of what a properly designed, quality built frameless enclosure can add to the beauty and value of a home. Each enclosure is adorned with C.R. Laurence Frameless Shower Hardware. As you browse through this catalog you'll see many examples of how we can add the WOW! to most every bathroom.



Custom Curved Glass Enclosure



Custom 90 Degree Enclosure

**TO SEE MORE BEAUTIFUL SHOWERS, LOG ON TO  
[CRLAURENCE.COM/GALLERY](http://CRLAURENCE.COM/GALLERY) AND VISIT OUR SHOWER GALLERY.**

# STANDARD 90° GLASS CLAMP

• For 5/16" (8 mm) to 3/8" (10 mm) Thick Glass

## SPECIFICATIONS:

**Materials:** Solid Brass or Stainless Steel

**Available Finishes:** Brass, Chrome, Satin Brass, Brushed Satin Chrome, Satin Chrome (Matte), Gold Plated, Gun Metal, Antique Brushed Nickel, Polished Nickel, Brushed Nickel, Satin Nickel, Ultra Brass, Antique Brass, Antique Bronze, Brushed Bronze, Oil Rubbed Bronze, Antique Brushed Copper, White, Black, Red, Polished Stainless, and Brushed Stainless.

**Glass Thickness Range:** 5/16" (8 mm) to 3/8" (10 mm)

**Hole Diameter Required:** 5/8" (16 mm) or 3/4" (19 mm) each panel

**Includes:** Gaskets and Wood Screw for wall mount application

**Note:** An additional set of gaskets is required for 5/16" (8 mm) glass (Cat. No. UCG77)

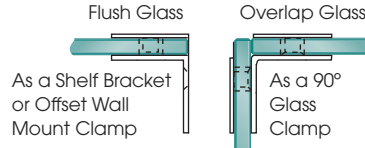

A truly versatile clamp that has two uses: as a 90° Clamp for vertical fixed panels in glass shower enclosures; as a bracket for horizontal glass shelves within the enclosure. Clamp design allows for flush mounting of shelf to wall, or for adjoining panels to meet with a minimal gap.

**CAT. NO. GCB90**  
Size: 1-3/4" (44 mm) Wide x  
1-3/4" (44 mm) High  
(each plate)



# CLEAR POLYCARBONATES, VINYL SEALS, AND EDGE WIPES

## POLYCARBONATE 'U' WITH BULB ATTACHMENT

**NEW!**

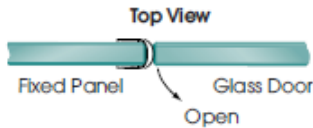

The Clear Polycarbonate 'U' With Bulb Attachment is a versatile seal that can be mounted to the edge of a door or panel for a variety of installation configurations. The soft Bulb portion of the Seal allows doors to swing both in and out of the enclosure if desired.

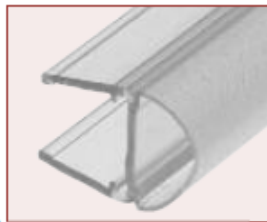

98" (2.49 M) STOCK LENGTHS

CAT. NO.	GLASS SIZE
PCR10	3/8" (10 mm)

## ONE-PIECE BOTTOM RAIL WITH CLEAR WIPE

• *Single-Piece Bottom Sweep*

This ultra clear One-Piece Bottom Rail is snapped on the bottom of the door to achieve a seal. Because it is a single-piece sweep, it means the vinyl seal that hangs down from the sweep will firmly direct the water back into the shower enclosure.

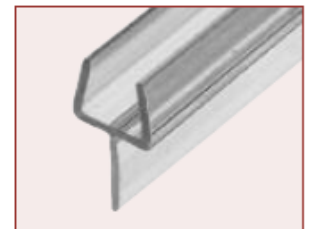
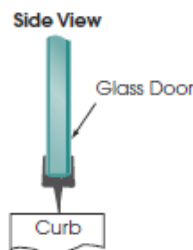

98" (2.49 M) STOCK LENGTHS

CAT. NO.	"X"	"Y"	GLASS SIZE
P501BR	7/16" (11 mm)	7/16" (11 mm)	3/8" (10 mm)
P661BR	1/2" (12 mm)	7/16" (11 mm)	1/2" (12 mm)



Custom 90 Degree Enclosure



Custom 90 Degree Enclosure



Custom 90 Degree Enclosure



Custom Inline Enclosure



Custom 90 Degree Enclosure



Custom Neo-Angle Enclosure



Custom Inline Enclosure



Custom Curved Enclosure



Custom Inline Enclosure



Custom 90 Degree Enclosure



Custom Curved Enclosure



Custom Neo-Angle Enclosure



Custom 90 Degree Double Door Enclosure



Custom 90 Degree Enclosure



Custom 90 Degree Enclosure



Custom Sliding Door Enclosure

# DELUXE SHOWER DOOR HEADER KITS

- For 5/16", 3/8", and 1/2" (8, 10, and 12 mm) Glass
- Secures Shower Enclosure Not Going to Ceiling
- Snap-in Filler Insert for Door Pocket Included
- Available in Up to Seventeen Finishes

The Deluxe Header Kit will provide additional support and a level of safety while securing glass panels not reaching the ceiling. Deluxe Header Kits are designed to allow installers to do in-house fabrication using a selection of component parts. Sold in 66", 98" or 144" lengths, each Header Extrusion has a narrow 1-1/4" (32 mm) face to minimize the visible sight line. 90°, 135° or Adjustable Corners are sold separately (see next page). Also available is a special Adapter Block for use on pivot hinge installations. Brass Wall Brackets are included in each kit. A Blank Mounting Bracket is offered separately for installations where the Header does not meet the wall at 90°, and the standard Wall Mounting Brackets cannot be used. Header is constructed of Aluminum Alloy.

This Header Kit is adaptable to Senior Prima, Senior Cardiff, Prima, Cardiff, Rondo or Shell Hinges, if using the Kit with Top and Bottom Mount Pivot Hinges. Adapter Blocks sold separately (see next page).

- Choice of Profiles: Round on One Side and Flat on the Other, or Flat on Both Sides of Header



SDH Series

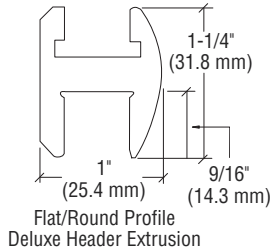

Flat/Round Profile  
Deluxe Header Extrusion



SQH Series

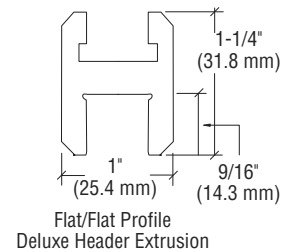

Flat/Flat Profile  
Deluxe Header Extrusion

## 98" (2.49 M) DELUXE HEADER KITS

SDH SERIES FLAT/ROUND CAT. NO.	SQH SERIES FLAT/FLAT CAT. NO.	FINISH
SDH980BA	SQH980BA	Brite Anodized

## EACH DELUXE HEADER KIT CONTAINS:

- 66" (1.67 m), 98" (2.49 m) or 144" (3.65 m) Piece of Header Extrusion
- 36" (.91 m) Piece of Snap-In Filler for Door Pocket
- Vinyl for 5/16" (8 mm) and 3/8" (10 mm) Glass (not needed for 1/2" (12 mm) Glass)
- Pack of BWB2 Brass Wall Mounting Brackets (Pack includes two Brackets)

**NOTE:** If choosing to use a Header Kit with 1/4" (6 mm) glass, Cat. No. HV140 Clear Vinyl may be ordered separately.

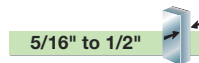

**DURALCO**  
PREMIUM ALUMINUM PRODUCTS FROM AUSTRALIA

## VISIT OUR SHOWROOMS:

### GRANADA SHOWROOM

#60 Granada Street, Villa Ortigas II, Quezon City  
+632 8725 8160

### ORTIGAS SHOWROOM

CW Home Depot Ortigas 1 Dona Julia Vargas Avenue, Cor. Meralco Ave., Pasig City  
+632 8633 5539

### FORT SHOWROOM

MC Home Depot, 32nd St., Cor. Bonifacio Boulevard, Bonifacio Global City, Taguig City  
+632 8816 0158

### ALABANG SHOWROOM

CW Alabang Home Depot Westgate, Alabang Zapote Road, Cor. Filinvest Ave. Alabang, Muntinlupa City  
+632 8771 1591



C.R. LAURENCE COMPANY

crlaurence.com

202S | crlaurence.ca crlaurence.qc.ca crlaurence.com.mx crlaurence.com.au usalum.com