



## The Carinya Collection

**carinya**  
RESIDENTIAL  
WINDOWS AND DOORS

[carinyawindows.com.au](http://carinyawindows.com.au)

**carinya**  
RESIDENTIAL  
WINDOWS AND DOORS





# CARINYA SMOOTH AS SILK

*With the design pedigree established in the demanding commercial window and door market, the Carinya residential range has been created by commercial window powerhouse Alspec to be the leader in its class.*

Carinya is the new name in premium quality residential windows and doors. The Carinya range has been developed by Alspec, one of Australia's most respected and long-standing suppliers of aluminium products to the commercial building industry.

Architects and builders will tell you: 'The choice of windows and doors can make or break the outcome of a building project!'

Alspec created the Carinya range in response to an approach by a leading homebuilder for superior quality windows and doors at an affordable price.

Thanks to the scale and strength of Alspec's commercial operations, the commercial and industrial pedigree of Carinya products ensures a level of performance and design normally beyond the homebuilder's budget.

Carinya windows and doors are an investment you will enjoy every day. In fact, the name Carinya is an indigenous word meaning 'Happy Home'.

*The very best in windows and doors is now within your reach.*

## The Classic Range

The Carinya Classic Range includes a variety of windows and doors suitable for all homes. Products include sliding windows, sliding doors, double hung windows and awning windows.

## The Select Range

The Carinya Select Range includes premium windows and doors for the discerning home buyer. Products include hinged doors, double hung windows and bi-fold doors.

*Carinya windows and doors:  
Commercially-bred. Clearly better.*

Carinya invest heavily on Research & Development to come up with innovative solutions in catering for all requirements in the National Construction Code.

Carinya have tested and developed products to meet a range of building requirements in up market homes and multi-unit Residential areas offering a complete solution for all your needs no matter how large or small a project may be.



Our Carinya Dealers are pleased to offer a solution for multiple keys for your doors and windows. It is possible to have 1 key for your front door, sliding door, french door, bi-fold door, sliding window, awning window, double hung window and security door.

**With Carinya's Master Key  
there's less keys... and less fuss!**

## Why Carinya is better

- ✓ Commercial design pedigree.
- ✓ Superior designer look - created by architects and design engineers.
- ✓ Suitable for all glass thicknesses from 4mm through to 10.5mm.
- ✓ Suitable for double glazing with up to 24mm insulated glass units.
- ✓ Infills, end caps and weather seal guard against air, water, grit and insect penetration and increase acoustic performance.
- ✓ Fully energy rated and certified to WERS
- ✓ Fully tested and certified to bushfire conditions up to BAL40.
- ✓ Fully tested and certified to high acoustic requirements.
- ✓ Fully tested and certified for cyclonic regions C & D.
- ✓ The only residential window & door system designed by a market leader in commercial doors and windows.





## The Classic Range

The Carinya Classic Range includes a variety of windows and doors suitable for all homes. Products include sliding windows, sliding doors, double hung windows and awning windows.





## Classic Sliding Window

### The Classic Range

The Carinya Classic Sliding Window is a unique combination of form and function not previously available in the residential category.

Carinya has many visible advantages over alternative products in addition to its obvious aesthetic qualities, these include:

- ✦ Exclusive handle located on the mullion for ease of access and cleaner lines.
- ✦ In built weather flaps - a feature of all Carinya windows - to reduce air and water infiltration, cover drain slots and minimise insect intrusion.
- ✦ Proprietary adjustable, non-corrosive roller system - the 'engine room' of these high performance windows - provides an effortless gliding motion that makes the window a joy to operate.
- ✦ Anti-lift block fitted above the sash to prevent manipulation and increase security.
- ✦ Mullion and transom end caps that ensure insects have no place to hide.

The entire Carinya Collection has been fully tested to meet or exceed Australian Standards AS2047, AS1170, AS1191 and AS3959.



Exclusive proprietary handle for ease of operation with optional colour finishes.



Stainless housing commercial grade rollers for all glass options.

## STREAMLINED HARDWARE

The Carinya Classic Sliding Window has been designed with matching stylish hardware, with the option for a lockable or non-lockable proprietary handle.

The slimline handle design, mounted in an easily accessible position on the rear of the sliding sash, offers ease of use and minimises view obstruction.

To maximise the performance and life of your window proprietary commercial rollers are used that have been tried and proven in commercial applications such as schools and offices. This ensures that your windows will always be easy to open, even with large sashes and heavier glass options.

All Carinya Sliding Window sashes feature corner blocks in all four corners of the sliding sash. These blocks make the sash more rigid, reducing twisting and movement. This reduction in movement increases the performance of the window by reducing opportunities for air and water infiltration.

An optional vent lock is also available allowing the sliding sash to be secured in a semi-opened position for increased safety.

### Applications

- New residential construction.
- Window replacement and renovation.
- Low-rise building.
- Suitable for cyclonic regions C & D.

### Specifications

- Maximum Sash Height: 1500mm
- Maximum Sash Width: 1200mm
- Maximum Single Glazed Thickness: 10.5mm
- Maximum Double Glazed Thickness: 18mm
- Maximum Sash Weight: 40kg
- \*subject to site conditions

### Options

- A range of sill options are available for applications requiring increased weather performance.
- A range of mullions and transoms complete with end caps for a quality finish.
- Choice of screening options with superior mesh solutions.
- Optional secondary glazing for high acoustic requirements.

### Configurations

Your Carinya Dealer can offer the typical standard configurations below, as well as custom options to suit your requirements:

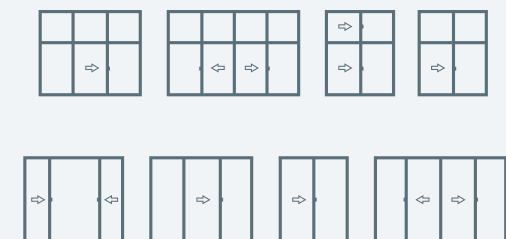

# High Performance Sliding Window

## The Classic Range

The Carinya Classic High Performance Sliding Window is a new development not previously available in the residential category for Australia's most demanding terrain requirements.

Besides a modern designer look, the Carinya Classic High Performance Sliding Window is packed with a multitude of performance features, many of which are simply not available in competing products:

- Rather than unsightly exposed tracks found in most residential windows, Carinya has a complete range of threshold and jamb infills as well as end caps to conceal all cavities. This not only provides a superior quality, commercial grade finish but also minimises places for insects, dirt and grit to gather.
- A range of attractive interlock options to meet a wide variety of wind load requirements
- Sills to suit the most severe conditions of residential construction.

The entire Carinya Collection has been fully tested to meet or exceed Australian Standards AS2047, AS1170, AS1191 and AS3959.



58mm wide rails and stile.



Commercial grade rollers up to 160kg.

## STREAMLINED HARDWARE

The Carinya Classic High Performance Sliding Window has been matched with commercially designed hardware to ensure style and durability in the harshest of environments.

Our Sliding Window Lock provides functionality and varying finish options for your project. This functional retractable handle design allows for ease of use and utilises 5 pin cylinder security for peace of mind.

To maximise the performance of your sliding window we have utilised our proprietary Alspec roller system used throughout our commercial range.

Stainless rollers and optional stainless cover track are also available for coastal environments, allowing for enduring performance and durability.

Both roller systems have been designed to interact with the stiles to create a strong and robust panel, minimising movement in joints and opportunities for air infiltration.

## Applications

- Region D Residential Construction for Cyclonic Compliance
- Double Glazing without adaptors for a premium option
- Low-Rise Multi-Unit Developments

## Specifications

- Maximum Panel Height: 1800mm
- Maximum Panel Width: 1200mm
- Maximum Single Glazed Thickness: 12mm
- Maximum Double Glazed Thickness: 18mm
- Maximum Sash Weight: 160kg
- Frame width available in 92mm

## Options

- A range of sill options available for increased structural, water performance and design flexibility.
- A range of internal interlocks complete with end caps for varying wind load requirements.
- Integral screening options for security or insect protection.

## Configurations

Your Carinya Dealer can offer the typical standard configurations below, as well as custom options to suit your requirements:







## Classic Sliding Door

### The Classic Range

The Carinya Classic Sliding Door is a product in the residential market having evolved out of a system designed for the high rise apartment market.

This commercial background means that besides a modern designer look, the Carinya Classic Sliding Door is packed with a multitude of performance features, many of which are simply not available in competing products:

- ✦ Rather than unsightly exposed tracks found in most residential doors, Carinya has a complete range of threshold and jamb infills as well as end caps to conceal all cavities. This not only provides a superior quality, commercial grade finish but also minimises places for insects, dirt and grit to gather.
- ✦ An internally concealed weather flap also reduces air and water infiltration and minimises insect intrusion through the drain holes.
- ✦ All Carinya sliding doors feature a choice of sill configurations catering for every weather performance requirement, including a wheelchair accessible sill.
- ✦ There is also a range of attractive interlock options to meet a wide variety of wind load requirements up to the most demanding cyclonic conditions.

**The entire Carinya Collection has been fully tested to meet or exceed Australian Standards AS2047, AS1170, AS1191 and AS3959.**



Functional and stylish Dual Point Yarra Curve door lock. Yarra Edge door lock with optional stylish colours also available.



Alspeg's high performance, commercial door roller used in the Carinya residential sliding door for smooth operation.

## STREAMLINED HARDWARE

The Carinya Classic Sliding Door has been matched with commercially designed hardware to ensure style and durability.

The Yarra Curve and Edge door locks provides functionality and varying finish options for your project. This functional design allows for ease of use and utilises 5 pin cylinder security for peace of mind.

To maximise the performance of your sliding door we have utilised a proprietary Alspeg roller system. It's the same system used throughout the commercial range and is available in two options - General use: for the majority of loads up to 80kg per panel; and Heavy duty commercial: designed for extra large sashes and major double glazing loads up to 160kg per panel.

Both roller options have been designed to integrate with the stiles to create a strong and robust panel, minimising movement in joints and opportunities for air infiltration.

### Applications

- New residential construction.
- Door replacement and renovation.
- Aged care & wheelchair requirements.
- Low-rise multi unit developments.
- Suitable for cyclonic regions C & D.

### Specifications

- Maximum Panel Height: 2400mm
- Maximum Panel Width: 1200mm
- Maximum Single Glazed Thickness: 10.5mm
- Maximum Double Glazed Thickness: 18mm
- Maximum Sash Weight: 160kg
- \*subject to site conditions

### Options

- A range of sill options available for increased structural, water performance and design flexibility.
- A range of interlocks complete with end caps for varying wind load requirements.
- Choice of configurations available, including stacking and corner options.
- A range of mid rails available for semi-commercial unit developments.

### Configurations

Your Carinya Dealer can offer the typical standard configurations below, as well as custom options to suit your requirements:

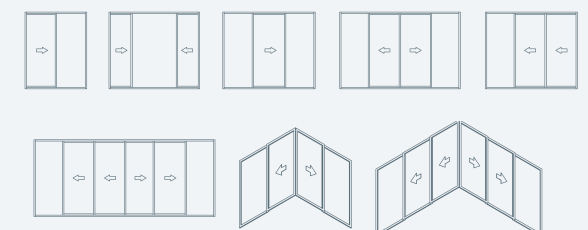





## Double Hung Window

### The Classic Range

The Carinya Classic Double Hung Window is a slimline design to complement heritage houses and new homes aiming for a designer look.

Carinya has many visible advantages over alternative products in addition to its obvious aesthetic qualities. These include:

- ✦ Specifically designed to accommodate screening within the head and sill to deliver that clean professional finish not available with many competitor products.
- ✦ The Carinya attention to detail includes bump stops top and bottom to prevent frame damage.
- ✦ Full perimeter weather piles reduce air and water infiltration.
- ✦ A choice of lockable or latchable handles are available.

**The entire Carinya Collection has been fully tested to meet or exceed Australian Standards AS2047, AS1170 and AS1191.**



Adjustable tensioning spiral or spring system.



Integrated sash handles with protective end caps.

## STREAMLINED HARDWARE

The Carinya Classic Double Hung Window has been designed with matching stylish hardware, with the option for a lockable or non-lockable handle.

All Carinya double hung window sashes feature corner blocks in all four corners of the sashes. These blocks make the sash more rigid, reducing twist and movement. This reduction in movement increases the performance of the window by reducing opportunities for air, water and dust infiltration.

These proprietary Carinya corner blocks also interact with the balances in both the top and bottom sashes to provide a stable and secure window.

The spring or spiral balances come in a range of lengths and strengths to suit a wide variety of different window heights and sash widths. Combined with an adjustable balance friction foot this ensures that your custom made window will operate smoothly for many years to come.

Specially designed finseals are fitted all around both sashes. These seals act as insulation to prevent drafts, dust, light and other contaminants coming in from outside through the edges of the windows.

The Carinya lock has optional colours and features keying with a C4 cylinder which allows all of your windows and doors to be keyed alike using the Carinya Master Key.

### Applications

- New residential construction.
- Window replacement and renovation.
- Low-rise building.

### Specifications

- Maximum Sash Height: 1090mm
- Maximum Sash Width: 1000mm
- Maximum Glass Thickness: 8.38mm Single Glazed
- Maximum Sash Weight: 20kg
- \*subject to site conditions

### Options

- Choice of screening options with superior mesh solutions.
- Security screens securely fitted within the head and sill.
- Integrated sidelights, highlights and lowlights.
- Spring or spiral balance types available.

### Configurations

Your Carinya Dealer can offer the typical standard configurations below, as well as custom options to suit your requirements:

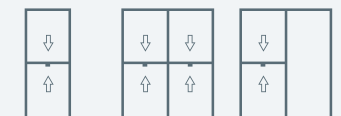



## Classic Awning Window

### The Classic Range

The Carinya Classic Awning Window is a mainstay range featuring two frame widths and multiple sash options.

Besides a modern designer look, the Carinya Classic Awning Window is packed with a multitude of performance features, many of which are simply not available in competing products:

- ✦ A designer bevelled edge frame is standard for Carinya awning and casement windows and a wide sash for high-end residential applications is also available.
- ✦ The integrated hinge design is incorporated entirely within the frame to achieve the clean designer finish.
- ✦ Flexibility is another hallmark of all Carinya windows. There's a choice of slim line 50mm or premium 92mm frame options.

**The entire Carinya Collection has been fully tested to meet or exceed Australian Standards AS2047, AS1170, AS1191 and AS3959.**

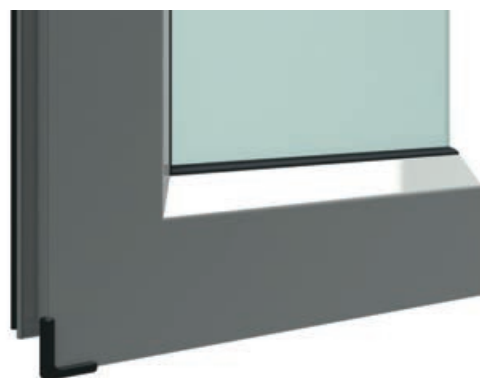

Commercial grade aluminium corner stake assembly.



Chain winder with optional sash restriction.

## STREAMLINED HARDWARE

The Carinya Classic Awning Window has been designed with matching stylish hardware, with the option for a lockable or non-lockable handle.

The integrated 50mm sill allows for a stable base for your window, allowing concealed fixings and comes complete with stylish end caps.

The Carinya chainwinder is available in standard or restricted opening, depending on the size and application of the sash. These winders have been tried and proven in commercial applications, such as schools and offices.

In a casement configuration, stays and cam handles are utilised to provide proven performance. These stainless steel stays offer support and friction control, catering for a range of sash size and weights for your application.

All Carinya sashes feature a commercially based aluminium corner stake, combined with screw fixings, allowing an extremely strong and durable sash.

Features such as corner protectors on the sash separate Carinya from other awnings on the market, whilst providing a practical and safe solution for your home.

### Applications

- New residential construction.
- Window replacement and renovation.
- Low-rise building.

### Specifications

- Maximum Sash Height: 2100mm
  - Maximum Sash Width: 1200mm
  - Maximum Glass Thickness: 10.5mm Single Glazed
  - Maximum Glass Thickness: 18mm Double Glazed
  - Maximum Sash Weight: 40kg
  - Maximum Sash Area: 1.4m<sup>2</sup>
- \*subject to site conditions

### Options

- A choice of a semi-commercial 60mm sash.
- Choice of 50mm or 92mm perimeter frame.
- Awning frame creates all fixed frame and interacts with couplers.
- Choice of screening options with superior mesh solutions.

### Configurations

Your Carinya Dealer can offer the typical standard configurations below, as well as custom options to suit your requirements:

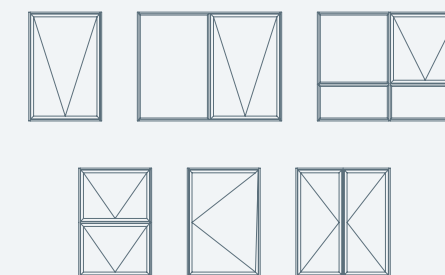



## *The Select Range*

The Carinya Select Range includes premium windows and doors for the discerning home buyer. Products include hinged doors, double hung windows and bi-fold doors.







## Double Hung Window

### The Select Range

The Carinya Select Double Hung Window is a distinctive combination of design and durability not previously available in the residential category.

Besides a modern designer look, the Carinya Select double hung window is packed with a multitude of performance features, many of which are simply not available in competing products:

- ✦ With a generous 92mm frame width this double hung is perfect for large openings up to 2.2 metres tall and 1 metre wide.
- ✦ The 92mm frame width allows for integrated screening within the width of the frame for a clean designer finish.
- ✦ Cleaning is a breeze. If required, both top and bottom sashes (or panels) can be removed thanks to special take out clips and a unique heavy duty sash balance system.
- ✦ The Carinya attention to detail includes bump stops to prevent frame damage, end caps to conceal sharp corners, as well as internal and external weather flaps that hide drainage slots and minimise insect intrusion.
- ✦ Full perimeter weather piles reduce air infiltration and improve acoustic performance.

**The entire Carinya Collection has been fully tested to meet or exceed Australian Standards AS2047, AS1170, AS1191 and AS3959.**

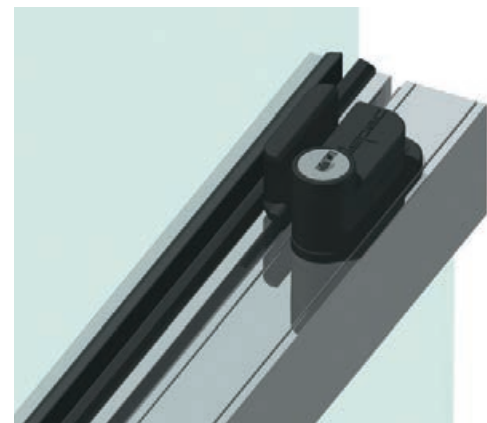

Alspec double hung latch with optional colours and keying options.



Easy take out clips on side jambs for removal of sash.

## STREAMLINED HARDWARE

The Carinya Select Double Hung Window has been designed with matching stylish hardware, with the option for a lockable or non-lockable handle.

All Carinya double hung window sashes feature corner blocks in all four corners of the sashes. These blocks make the sash more rigid, reducing twist and movement. This reduction in movement increases the performance of the window by reducing opportunities for air, water and dust infiltration.

The balance system for the Carinya Select window is designed and manufactured for large and heavy windows. The balance features a unique "block and tackle" design that caters for heavy weights and will provide smooth operation of even large windows. As the balances are engineered for specific sizes and weights of windows, they require no adjusting during or after installation so as to provide long service for many years to come.

The innovative design of these balances means that they travel up and down with the windows and so they are not visible at any time. This design also means that both top and bottom sashes can be easily removed to allow easy cleaning of the window from inside the house.

### Applications

- New residential construction.
- Window replacement and renovation.
- Low-rise building.

### Specifications

- Maximum Sash Height: 1090mm
- Maximum Sash Width: 1000mm
- Maximum Single Glazed Thickness: 10.5mm
- Maximum Double Glazed Thickness: 18mm
- Maximum Sash Weight: 20kg
- \*subject to site conditions

### Options

- Choice of screening options with superior mesh solutions.
- Security or flyscreens securely fitted within the frame width.
- Integrated sidelights, highlights and lowlights.

### Configurations

Your Carinya Dealer can offer the typical standard configurations below, as well as custom options to suit your requirements:

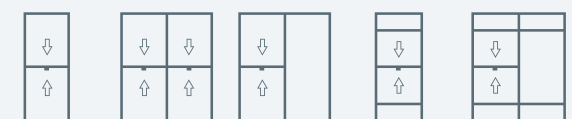



## Select Hinged Door

### The Select Range

The Carinya Select Hinged Door is a premium product designed for those seeking superior functionality and style as a grand entry to their home.

Consisting of a modern designer look, the Carinya Hinged Door extrusions are a consistent 85mm wide face on both the stiles and rails, combined with a 40mm thick panel. This allows a balanced visual face and allows a vast array of hardware lock options. Combined with optional spigots, these door panels are superior in strength and performance.

- ✦ A generous 125mm frame allowing for integrated screening, as well as multiple combinations of single, double or sidelights, the Select Hinged Door is the optimal choice.
- ✦ A 92mm frame is also available for when screening is not required or for typical open out configurations. This also allows flexibility in design and budget.
- ✦ The Carinya attention to detail includes concealed flush bolt brackets, reducing visible fixings, as well as custom extrusion design allowing for clean interaction with door hardware.

**The entire Carinya Collection has been fully tested to meet or exceed Australian Standards AS2047, AS1170, AS1191 and AS3959.**



Carinya 125mm Hinged Door Sill Detail



Exclusive Killara furniture with 4 point locking and snib release

## STREAMLINED HARDWARE

The Carinya Select Hinged Door has been designed with hardware from the start, not as an after thought. All locks and flush bolts blend seamlessly with the custom extrusion for a professional finish.

The Carinya Select Hinged Door sashes feature an optional commercial door spigot, allowing a strong and robust panel for enduring use, free of twist and movement.

Standard lock hardware options include Alspec's custom Australian made Killara Furniture, combined with Lockwood's proven Optimum mortice lock. Fitting snug within the stile and allowing an extended 40mm backset, this lock removes the common issue of minimal key distance to the jamb. Other lock options include commercial locksets and furniture for a complete choice, as well as two and four point locking for single or double doors.

Custom flush bolt guides have been designed to remove visible fixings from the extrusion faces, allowing a tighter seal saving potential energy costs while giving a professional, uninterrupted clean visible surface.

Killara Xtra Furniture allows for an internal snib option with lock indicator and two or four point locking for all configurations.

### Applications

- New residential construction.
- Window replacement and renovation.
- Low-rise Multi-Unit Developments
- Aged Care and Wheelchair Requirements

### Specifications

- Maximum Panel Height: 2400mm
- Maximum Panel Width: 900mm
- Maximum Single Glazed Thickness: 10.5mm
- Maximum Double Glazed Thickness: 24mm
- Maximum Panel Weight: 50kg
- 125mm or 92mm Frame

### Options

- A range of sill options for internal or external opening.
- A range of sidelight options including glass louvre options.
- Integral screening options for security or insect protection.

### Configurations

Your Carinya Dealer can offer the typical standard configurations below, as well as custom options to suit your requirements:

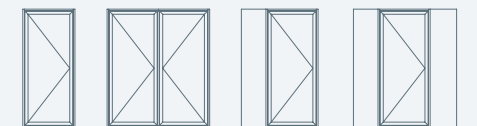





## Select Bi-Fold Door

### The Select Range

*A premium solution for those seeking superior functionality and style in the alfresco area of their home.*

The Carinya Select Top and Bottom Bi Fold System features flat sill options for smooth accessibility and optional mid rails with multi-point locking in a range of opening configurations.

For a modern designer look, the Carinya Bi Fold extrusions are a consistent 85mm wide face on both the stiles and rails. This allows a balanced visual face and allows a vast array of hardware lock options. Combined with commercial grade spigots, these door panels are superior in strength and performance.

The Bottom rolling Bi Fold system features the innovative F2/F3 Centor Bottom rolling hardware which overcomes the requirement for any structural beam as needed in a top hung Bi Fold system. This is ideal for the new or renovation market that want an Alfresco style opening without the additional cost of a structural beam.

The Top rolling Bi Fold system features the Alspec commercial grade E2/E3 Centor rolling hardware which has been used and proven overtime in commercial projects. This is ideal for the new construction market that want an Alfresco style opening.

The Carinya attention to detail includes concealed flush bolt brackets, reducing visible fixings, as well as custom extrusion design allowing for clean interaction with door hardware. The Centor hardware is of the highest quality which is backed by a 10 year warranty.



Flush Bi-Fold window sill for smooth transition in kitchen servery application.



Exclusive Killara furniture with 4 point locking and snib release

## STREAMLINED HARDWARE

*The Carinya Select Bi-Fold Door has been internally designed to blend with the hardware. All locks and flush bolts blend seamlessly with the custom extrusion for a professional finish.*

The sashes feature a commercial door spigot, allowing a strong and robust panel for enduring use making the panel free of twist and movement.

Standard lock hardware options include Alspec's custom Australian made Killara Furniture, combined with Lockwood's proven Optimum mortice lock. Fitting snug within the stile and allowing an extended backset; this lock removes the common issue of minimal key distance to the jamb. Other lock options include commercial locksets and furniture for a complete choice, as well as two and four point locking on the active leaf panel.

Custom flush bolt guides have been designed to remove visible fixings from the extrusion faces, allowing a tighter integrated sealing saving potential energy costs while giving a professional, uninterrupted clean visible surface.

Killara Xtra Furniture allows for an internal snib option with lock indicator and two or four point locking for all configurations.

### Applications

- Renovation market
- New Residential Construction
- Window Replacement and Renovation
- Low-Rise Multi-Unit Developments
- Aged Care and Wheelchair Requirements

### Specifications

- Maximum Panel Height: 2400mm
- Maximum Panel Width: 900mm
- Maximum Single Glazed Thickness: 10.5mm
- Maximum Double Glazed Thickness: 24mm
- Maximum Panel Weight: 40kg (E2) 100kg (E3)
- 92mm Frame

### Options

- A range of sill options for water or recessed openings.
- A range of fixed light options including glass louvres.
- Retractable screening options for insect protection.

### Configurations

Your Carinya Dealer can offer the typical standard configurations below, as well as custom options to suit your requirements:

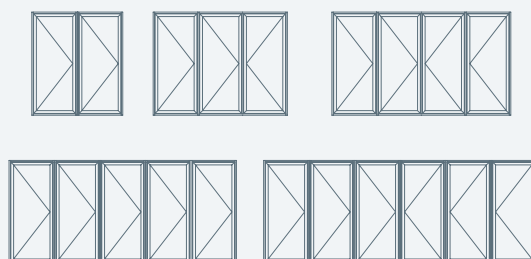





Images courtesy of Centor.



Images courtesy of Centor.

## Centor S1E Eco-Screen

The S1E Eco-Screen™ from Centor is a revolutionary product providing eco-friendly retractable insect screening and solar control with fingertip operation. This product is the evolution of Centor's award-winning S1 Insect Screen.

S1E allows homeowners to have complete control of their living environment. Used singly or paired together S1E is ready for use whatever the season or time of day. S1E retracts horizontally and discreetly into its frame when not in use – a revolutionary solution for those who refuse to compromise on style. For a single function system up to 3.9m wide choose an insect screen to 3.2m high or a sun filter blind to 2.45m high. Create a multi-function system selecting both fabrics for a two-in-one screening solution for openings up to 3.9m wide and 2.45m high. The insect screen and sun filter fabrics prevent insects entering the home and provide solar control.

For larger openings between 3.9m wide and 7.6m wide select a double system, choosing an insect screen up to 3.2m high or sun filter blind up to 2.45m high. The solar control blind doubles as a projection screen for either indoor or outdoor viewing. Mechanisms within the system enable the blind to be left partially open, allowing visitors to pass through the door way without the hassle of opening and closing the blind.

The considered design of the S1E Eco-Screen™ complements any large opening. Available in a natural anodised finish, custom colours and real wood veneers, it's mechanisms are concealed within the frame so screen and frame become an integrated unit.

A range of Centor innovations ensure the whole package functions simply and smoothly.

### Load Balancing Technology™

Load Balancing Technology™ (LBT™) (patent pending) allows for the effortless fingertip control synonymous with Centor products. With no crude spring-loading to fight against, the screen's lead-stile remains firmly in any chosen position until further pressure is applied. Load-balancing also means far greater tension across the screen or blind, minimising the tendency for sag.

### Tight Technology™

Tight Technology™ manufacturing techniques ensure control of the horizontal edges of the screen so they remain straight and tight across the widest spans.

### Shock absorption

In the majority of cases the shock absorption mechanism prevents system damage by redirecting impact away from the screen.

### Self-feeding mechanism

Should winds blow the screen out of the top or bottom channels the fabric will self-feed back onto the roll when retracted.

### Materials

S1E is manufactured in a combination of aluminium, stainless steel and reinforced engineering polymers. The blind is available in sun filter fabric. The tough PVC-coated polyester screen mesh is hardwearing and resistant to damage caused by pets and children.

### Testing

The S1E Eco-Screen™ has undergone cyclic testing to 400,000 operations in a laboratory and extensively exposed to dust, mud, sand and corrosive atmosphere to ensure it is a product for the real world. It has withstood impact testing with a 17kg punching bag 100 times and considerable pushing, poking and prodding to simulate real life usage

### Single function system

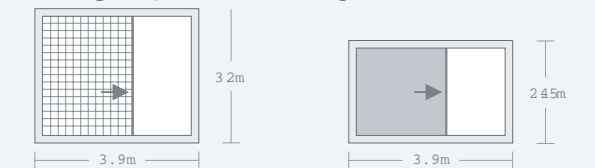

Option 1

Screen from left or right

Option 2

Blind from left or right

### Double function system

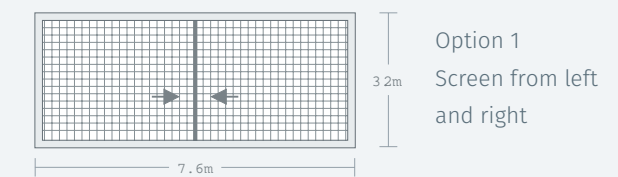

Option 1

Screen from left and right

Option 2

Blind from left and right

### Multi-function system

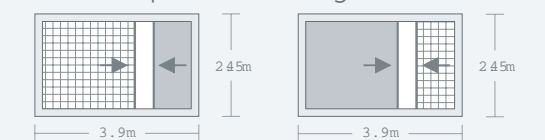

Option 1

Screen from left, Blind from right

Option 2

Screen from right, Blind from left



# A Solutions Focused Approach

Carinya invest heavily on Research & Development to come up with innovative solutions in catering for all requirements in the National Construction Code. Working with Architects and Builders, Carinya have tested and developed products to meet a range of building requirements to cater for upmarket homes and multi-unit Residential areas offering a complete solution for all your needs no matter how large or small a project may be.



This icon ensures that our products have undergone stringent testing to ensure that it has met all requirements for windows in BAL-40 zones under AS3959-2009



This icon found in our range of commercial, residential and screening products ensures they have been tested to meet and exceed Australian Standards for Cyclonic Compliance in regions C & D.



Ensure the energy rating on your windows is WERS rated to be confident of its true performance. Visit [wers.net](http://wers.net) for more info.



Carinya Master Key offers the convenience of having 1 key for all your windows and doors. Carinya Master Key - Less keys, less fuss!



When your family's safety and security is of utmost importance, look towards Invisi-Gard security mesh compatible products for peace of mind.



Look for KidScreen compatible products to ensure compliance to building construction requirements for child fall prevention without compromising the look of your windows.

## Energy Efficient Glazing

*Now you can install green, green glass at home - with designer style!*

The Carinya Collection of aluminium framed windows and doors has been specifically designed to be environmentally friendly, reflecting Carinya's commercial market heritage, where thermal and acoustic performance are often critical.

Of all building materials including glass, timber and masonry only one material is 100% recyclable - Aluminium.

Windows and doors are vital to the energy efficiency of any home. Research by the Sustainable Windows Alliance of Australia shows the typical Australian home can achieve an increase of 2 to 2.5 stars energy efficiency simply by upgrading the windows and doors.

Unlike many aluminium doors, Carinya has been designed for all major forms of eco-friendly glazing options without any alteration to the frame or any unsightly additions.

Carinya frames are designed for eco-friendly Low E glass, high thermal and high acoustic performance 10.5mm glazing and 24mm double glazing, usually the most energy efficient option of all.

To maximise the energy efficiency of your glazing discuss your project with a specialist Carinya Dealer and/or your architect or designer.

Remember the three most important issues for achieving maximum energy efficiency in a home are:

- Orientation - always try and have living areas facing north with seasonal or variable shading.
- Insulation.
- Window and door quality and performance - with double glazing nearly always the most energy efficient.



*The Housing Industry Association of Australia (HIA) strongly suggests you ensure the energy rating on your windows is WERS rated to be confident of its true performance.*

Carinya gives you that confidence as the entire Carinya Collection has been WERS rated for performance.

WERS stands for the Window Energy Rating Scheme that is managed by the Australian Window Association. WERS enables windows to be rated and labelled for their annual energy impact on a whole house, in any climate of Australia. WERS acts as a fair, rigorous and credible system for testing

energy performance claims. It is about certified performance.

Energy rating for windows is here to stay as part of the federal government's commitment to improving energy efficiency and reducing greenhouse gas emissions.

The flexible glazing options available in The Carinya Collection means that our windows and doors compare favourably in WERS performance and the resale value and comfort of your home are improved by the use of the high performance Carinya windows and doors.

For more information visit the WERS website: [www.wers.net](http://www.wers.net)



# Cyclonic Compliance

The Carinya Classic Sliding Window and Classic Sliding Door has been created by Alspec to be the ideal selection for regions requiring Cyclonic Compliance. As a residential window, this is suitable for all housing construction, including portable buildings and other accommodation requirements.

Affecting the eastern, northern and western coastlines of Australia, and characterised by strong winds and large volumes of moisture, tropical cyclones place enormous stress on the building envelope. The use of windows and doors designed and manufactured to meet the highest pressure, impact and water performance requirements will minimise the possible damage that cyclones can cause.

Alspec Cyclonic Window, Door and Screening Systems have undergone extensive independent NATA accredited testing to provide assurance that they exceed all structural, water and debris impact performance requirements for cyclone regions C and D. The following systems listed provide superior functionality and style along with the performance demanded by the extreme weather conditions encountered in cyclonic regions:

- Carinya 50mm Classic Sliding Window
- Carinya 92mm High Performance Sliding Window
- Carinya Classic Sliding Door



Look for this symbol in our range of commercial, residential and screening products to ensure they have been tested to meet and exceed Australian Standards for Cyclonic Compliance in Regions C & D.

# Carinya BAL-40 Bushfire Windows & Doors

The Carinya BAL-40 aluminium range has been designed to withstand temperatures of up to 40KW without failure to the glazing system while complying with AS2047. Protection from ember attack and burning debris preventing internal ignition to the building prevents possible loss of homes from the start.

Bushfires in Australia are almost a common occurrence during the hotter months due to Australia's hot and dry climate. Bushfire events in New South Wales, South Australia, Canberra and Victoria have been the most tragic bushfires events to occur in Australia's history.

The Carinya BAL-40 range successfully exceeded system test requirements outlined in AS1530.8.1 while remaining in operation after the test. Although there are no requirements set for operation after a test, having peace of mind in functioning allows for potential egress and access of the building by occupants or fire authorities.

These results are possible through the extensive Research & Development adding to the high quality design and functionality of this product.

When dealing with a BAL-40 requirement, specify Carinya to ensure compliance to Australian standards. All Carinya BAL-40 windows are identified with a label to ensure quality and compliance of the product to assist with certification onsite.

## Bushfire Attack Levels

Bushfire Attack Level (BAL)	Description of predicted bushfire attack and levels of exposure
BAL - LOW	There is insufficient risk to warrant specific construction requirements
BAL - 12.5	Ember attack
BAL - 19	Increasing levels of ember attack and burning debris ignited by windborne embers together with increasing heat flux between 12.5 and 19 kW m <sup>2</sup>
BAL - 29	Increasing levels of ember attack and burning debris ignited by windborne embers together with increasing heat flux between 19 and 29 kW m <sup>2</sup>
BAL - 40	Increasing levels of ember attack and burning debris ignited by windborne embers together with increasing heat flux with the increased likelihood of exposure to flames
BAL - FZ	Direct exposure to flames from fire front in addition to heat flux and ember attack

## Carinya BAL-40 Product Range consists of:

- Classic Sliding Window
- Classic High Performance Sliding Window
- Classic Awning window
- Classic Sliding/Stacking Door
- Classic Fixedlight
- Select Hinge Door
- Select Double Hung Window
- Fall Prevention KidScreens



This icon ensures that our products have undergone stringent testing to ensure that it has met all requirements for windows in BAL-40 zones under AS3959-2009



# Simple Screening Solutions

Don't forget your screening options!

Carinya products have been designed to accept screening products without the need for unsightly adaptors or added material. Door and window screening provides protection from insects and other unwanted 'guests' to your home, whilst minimising the impact on your view. In addition to standard fibreglass and aluminium insect screening, your Carinya Dealer can also offer the latest technology in high visibility screening using BetterVue® screening to maximise your view.



## High Visibility Flyscreening

Improved Visibility Insect Screening (IVis)

Greater Openess provides:

- 20% better airflow, allowing in light and fresh breezes
- 20% more optical clarity for a sharp, more brilliant image
- 10% better insect protection
- Infused with Microban antimicrobial product protection
- Suitable for all window and patio screen door applications



## Invisi-Gard - Security Screening

If security screening is desired for your Carinya Residential Window or Door, Invisi-Gard's Marine Grade 316 Stainless Steel Security Screens is your ideal choice for unmatched durability, protection and performance.

Fixed security screens are becoming more of a requirement for the Invisi-Gard security conscious home owner. New homes and renovations of today often incorporate large windows and doors as features in the overall design of the home. To cover these windows and doors in conventional security grilles would seriously detract from the visual appeal of the home or obscure vision and as a result of this, security is often not an option.

Invisi-Gard fixed security screens combine the proven strength and security of 316 Marine Grade Stainless Steel Mesh with extruded aluminium perimeter framing to create a security screen that looks great whilst providing excellent security.



## KidScreen - Kid Safe

KidScreen Window Fall Prevention screens are without question the best investment for your children's safety. They are also the best investment for the look and value of your home.

KidScreen Window Fall Prevention screens are a unique patent design, cost effective barrier solution designed specifically for child protection of openable windows. Recently presented with a highly commended Award from the "Australian Windows Association Most Innovative Window Component 2013".

The use of KidScreen Window Fall Prevention screens when secured to the window means it can be left fully open allowing natural air ventilation of the particular window type. No restricted opening is required as it acts similar to a security screen without the premium cost.

All KidScreen Window Fall Prevention screens are custom built, made to measure to meet the exact requirement of the National Construction Code 2013 (Vol 1: D.2.24 & Vol 2: 3.9.2.5) ensuring that your children are in the safest possible environment.

# Carinya Master Key

Sick of having many keys for different locks?

Our Carinya Dealers understand this inconvenience and are proud to offer our Carinya Master Key, eliminating multiple keys for your doors and windows.

Carinya Master Key offers the convenience of having 1 key for your front door, sliding door, french door, bi-fold door, sliding window, awning winder, double hung window and security doors.

Carinya Master Key - Less keys, means less fuss!

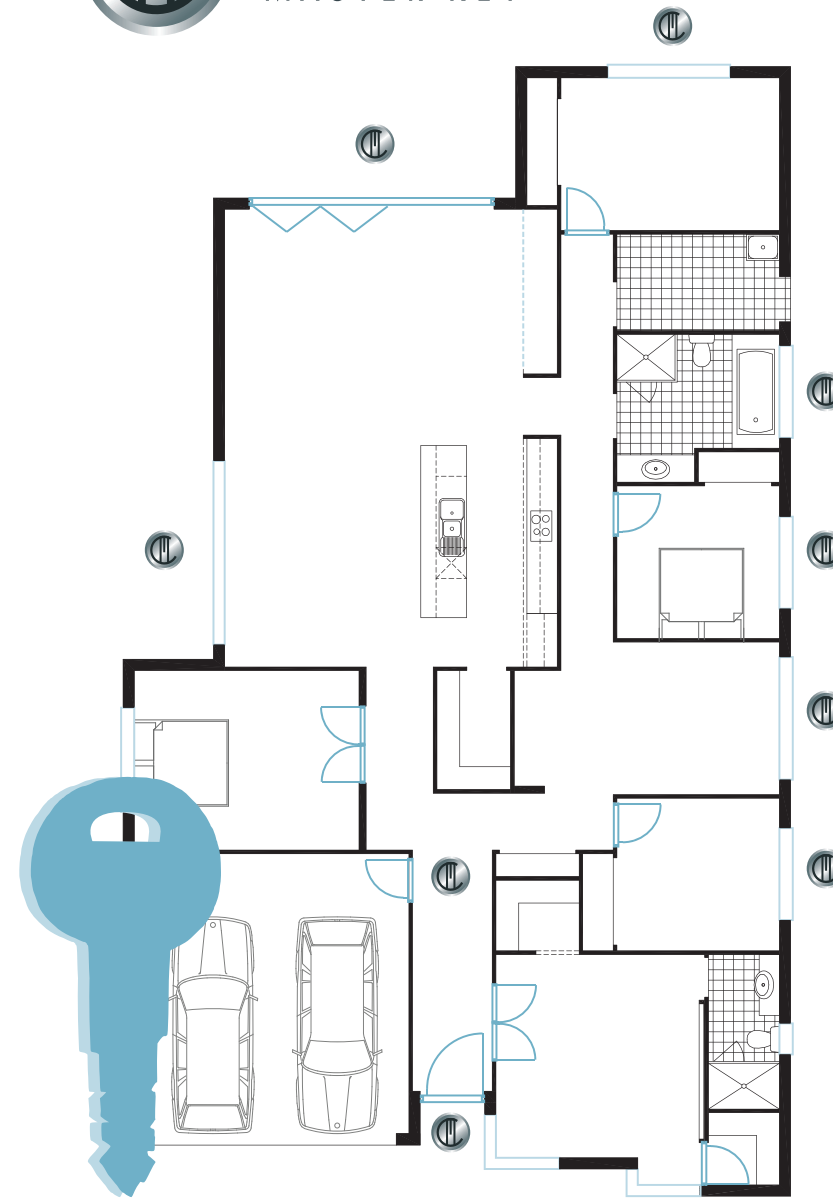

One key for all your windows AND doors!

# Colour Options

Depending on the look you require, you have many colour options for your Carinya Windows and Doors. Your Carinya Dealer can help you through this process of selecting a perfect match to your project.

Carinya Windows and Doors can be finished by one of two options for aluminium:

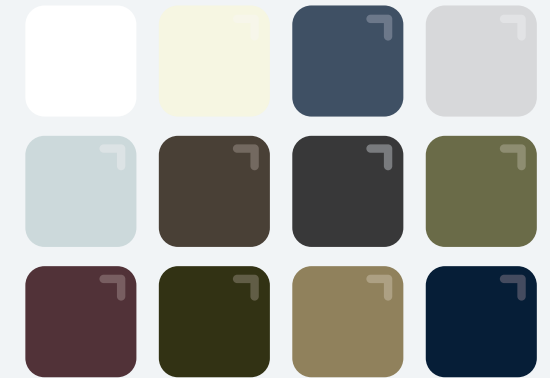

# Powder Coating

- A tough and durable option allowing for a wide range of colours.
- A choice of world leading suppliers of powder finishes.
- Finishing is provided by supplier accredited Alspec branches, as well as selected quality contractors.
- Warranties are available. Depending on your finish option, you will receive a warranty ranging from 7 years (film and colour integrity) to 15 years (film and colour integrity).

# Anodising

- You may prefer a choice of anodising, an electro-chemical treatment available in standard finishes, natural anodised and non standard, bronze and black.